

LIVRAISON
SUR CHANTIER

K760

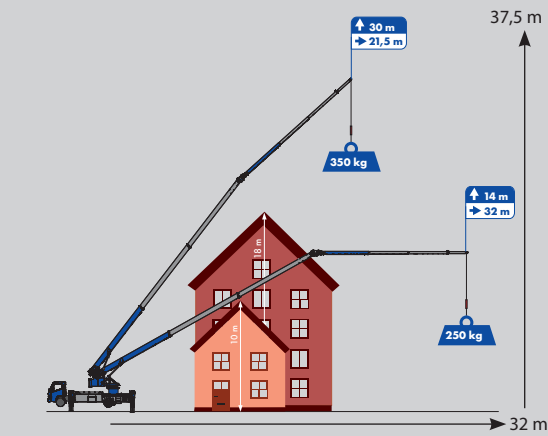

Hauteur sous crochet max. 37,5 m / Déport max. 32 m

Charge max. 4.000 kg

Jib télescopique hydraulique

Poids total du camion : $\leq 7,5$ t



**LIVRAISON
SUR CHANTIER**



Location . Vente . SAV . Formation

K760

Equipements



Système de mât

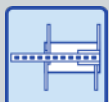

Stabilisation en H

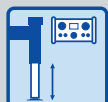

Stabilisation automatique

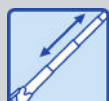

Jib télescopique hydraulique



Double vérin de Jib



Double vérin de mâtage



Treuil de télescopage



Rotation 360° à l'infini



Système de contrôle



Radiocommande



Moteur Diesel



Carénage complet



Mode de sécurité pour personnes



Motorisation hybride (opt.)



Nacelle (opt.)



Accessoires (opt.)



Crochet pour palonniers (opt.)

Informations techniques

Charge utile (stand./opt.)	2,0/4,0 t
Hauteur sous crochet max.	37,50 m
Longueur de flèche	39,00 m
Largeur de stabilisation (min.)	3,03 m
Largeur de stabilisation (max.)	5,29 m
Capacité du treuil	2.000 kg
Portée (2.000 kg - 500 kg)	5,00 - 11,65 m
Rallonge 3 (350 kg)	13,65 m
Poids total du camion (min.)	≤ 7,49 t

*en fonction du type de camion

Plage de travail

Charge	Portée	Hauteur
2.000 kg	6,00 m	23,00 m
1.000 kg	13,50 m	18,00 m
500 kg	22,00 m	18,00 m
250 kg	32,00 m	14,00 m

Plage de travail 4t*

Charge	Portée	Hauteur
4.000 kg	3,50 m	11,00 m
2.500 kg	7,00 m	6,50 m

*avec 2 brins

Abaque de charge*

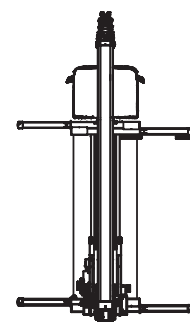
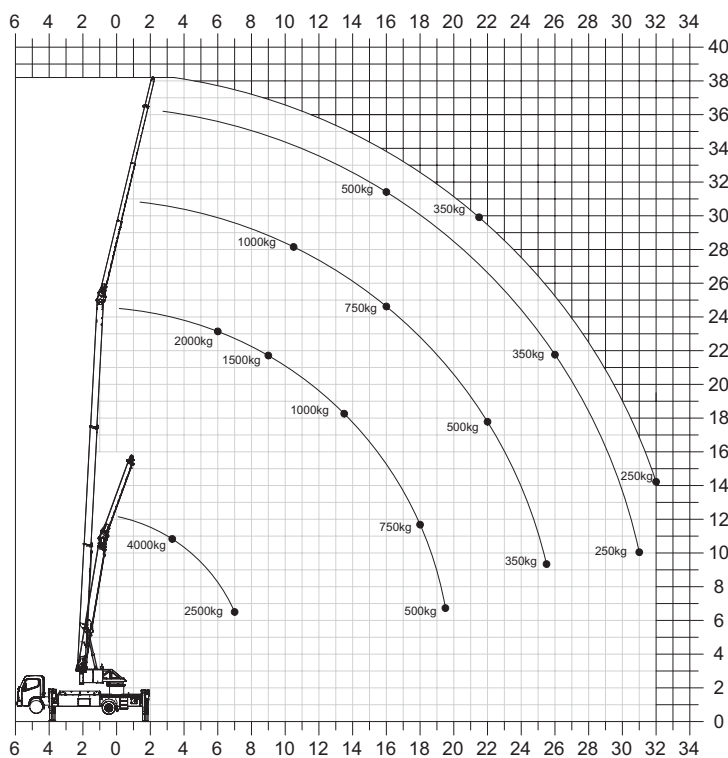

Abaque de nacelle*

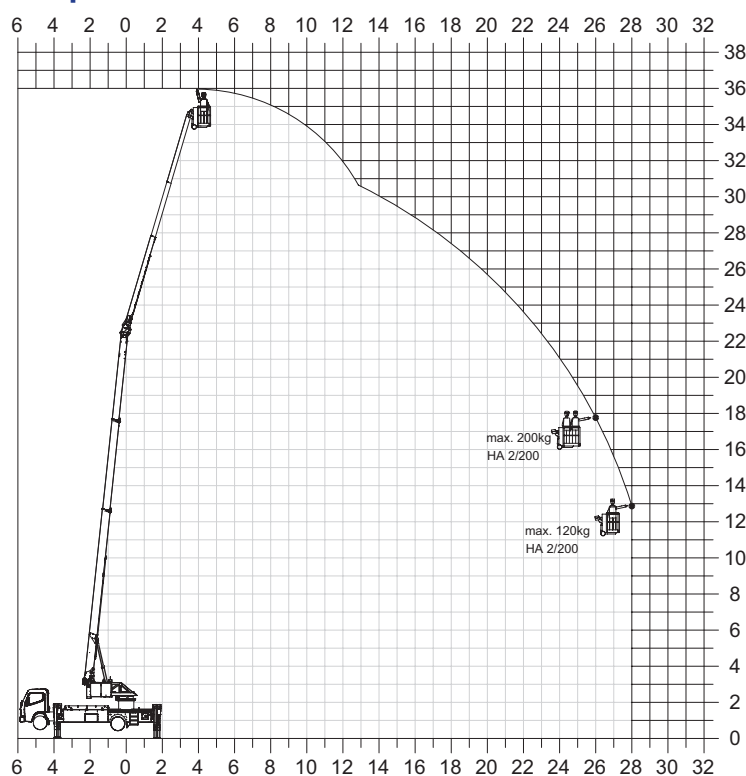

*Les valeurs de portée varient selon le véhicule porteur.

Sous réserve de modifications techniques. Toutes les dimensions sont des valeurs approximatives et dépendent du véhicule porteur concerné. Des modifications des fonctions et des performances sont également possibles. Les informations reflètent les caractéristiques de l'appareil au moment de

Stand: 03/2023

Klaas All Road - Location Vente SAV Formation Financement

Siège social : 6 allée des primevères - 60440 Nanteuil-le-Haudouin

Tél : 01 43 00 55 96 | contact@klaas.fr